



# D

Páginas **80 - 83**



**CHAPA TREPANADA  
PORTA-VEHÍCULOS**  
80



**GUÍA CORREDERA 42X40  
Y CARROS**  
80



**CAJETINES DE TABLA**  
81 - 82



Pamplona



D

## CHAPA TREPANADA (porta-vehiculos) PERFORATED METAL PLATE (VEHICLE CARRIER)

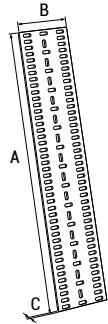
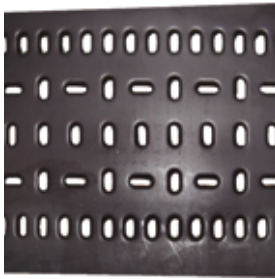

### Chapa trepanada

Referencia	Material	Acabado	Kg	A	B	C
DCTA1	acero	bruto	54,00	3000	750	3
DCTA2	acero	bruto	47,00	3000	650	3
DCTA6	acero	bruto	36,00	2500	600	3
DCTA25	acero	bruto	30,00	2500	500	3
DCTA26	acero	bruto	29,00	2000	600	3
DCTA5	acero	bruto	24,00	2000	500	3

Nota: Opción inoxidable, aluminio y espesores

## GUÍA CORREDERA EN ACERO STEEL SLIDE RAIL

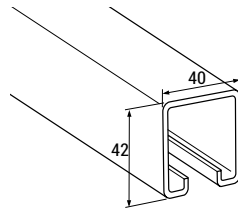
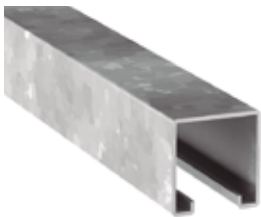

### Perfil guía N°40 (42 x 40 mm.), para plegador

Referencia	Material	Peso (kg)	Largo (mm)
DGRP B	galvanizado	2,34	6800

↓

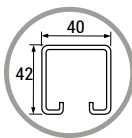
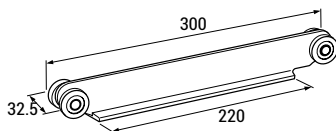

### Carro central corredero, para guía N°40

Referencia	Material	Acabado	Peso (kg)
DRPB	acero	pintado	0,74

↓

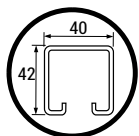
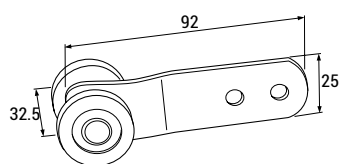

### Rodamiento superior sencillo para guía corredera N°40

Referencia	Material	Acabado	Peso (kg)
DRGPB	acero	cincado	0,12

## CAJETINES DE TABLA PLANK BOXES

### Cajetín de tabla ancho (para soldar)

Referencia	Material	Tipo	Kg	L	A	Int
DCT	acero	largo	0,40	155	52	29
DCTAI	inoxidable	largo	0,31	155	52	26
DCTA	aluminio	largo	0,09	155	52	29

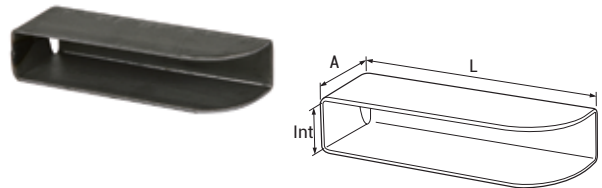

### Cajetín de tabla ancho (modelo "E") (para soldar)

Referencia	Material	Tipo	Kg	L	A	Int
DCTSCE	acero	corto	0,19	76	52	26
DCTSLE	acero	largo	0,64	255	52	26

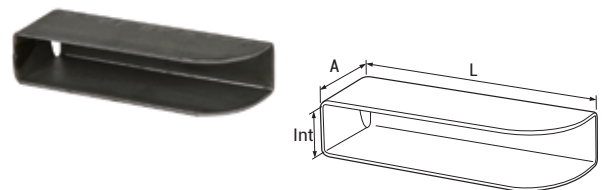

### Cajetín de tabla estrecho (para soldar)

Referencia	Material	Tipo	Kg	L	A	Int
DCTS	acero	corto	0,33	130	52	26
DCTSI	inoxidable	corto	0,27	130	52	26
DCTSA	aluminio	corto	0,13	130	52	26
DCTSL	acero	largo	0,40	155	52	26

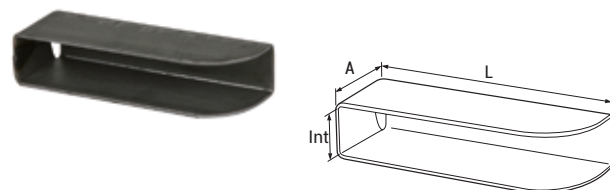

### Cajetín de tabla estrecho-largo (para soldar)

Referencia	Material	Tipo	Kg	L	A	Int
DCTSL	acero	largo	0,40	155	52	26
DCTSLI	inoxidable	largo	0,31	155	52	26
DCTSEI	inoxidable	largo	0,60	300	52	26

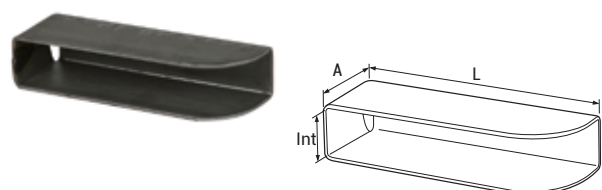

### Cajetín de tabla con rebaje (para soldar)

Referencia	Material	Tipo	Kg	L	A	Int
DCTR	acero	corto	0,19	135	50	25
DCTRI	inoxidable	corto	0,15	135	50	25
DCTRAA	aluminio	corto	0,07	135	50	25

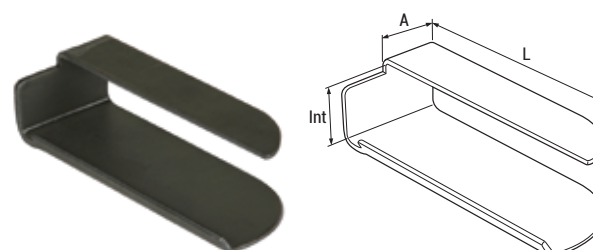

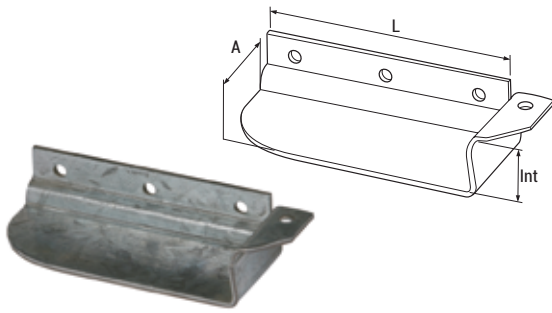

### Cajetín de tabla con rebaje (para remachar)

Referencia	Material	Tipo	Kg	L	A	Int
DCTRA	aluminio	corto	0,09	135	51	25
DCTG	galvanizado	corto	0,28	135	51	25
DCTRIR	inoxidable	corto	0,28	135	51	25

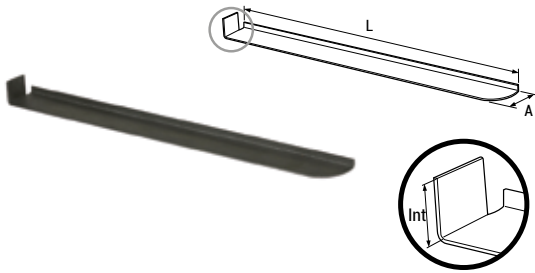

### Cajetín de tabla (1/2) (para soldar)

Referencia	Material	Tipo	Kg	L	A	Int
DCTML	acero	largo	0,45	460	44	25
DCTMLI	inoxidable	largo	0,39	460	44	25

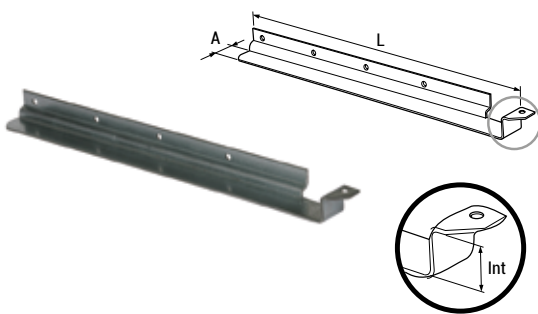

### Cajetín de tabla (1/2) (para remachar)

Referencia	Material	Tipo	Kg	L	A	Int
DCTAL	galvanizado	largo	0,46	400	31	25



Auxiliar Carrocera S.A.  
Pol. Landaben Calle A S/N  
31012 Pamplona (Navarra)  
Horario 8:30 – 13:30 / 15:30 – 18:30

Administración (+34) 948 18 73 16  
Departamento comercial (+34) 948 18 85 19  
669 044 143 - 696 001 017  
www.auxiliarcarrocera.com  
administracion@auxiliarcarrocera.com

**auxiliar  
carrocera**

**CATÁLOGO**  
CATALOGUE