



F

Páginas **110 - 113**



**PERFILES DE
EMBELLECIMIENTO**
110



**VIERTAGUAS Y
BISAGRAS DE MALETERO**
110 - 111





**GUÍA Y GANCHOS DE
CARNICERO**
111 - 112



Pamplona

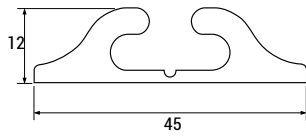





Goma correspondiente  Ref. G7

Perfil yugo de 45, N°2

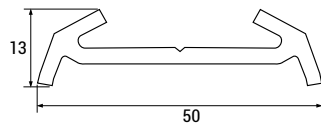
Referencia	Material	kg/m	Largo	Ancho
F2	aluminio	0,630	5000	45



Goma correspondiente  Ref. G16

Perfil yugo de 50, N°10

Referencia	Material	kg/m	Largo	Ancho
F10	aluminio	0,480	5000	50

↓

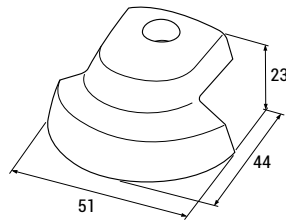

Terminal, para perfil N°10

Referencia	Material	Peso (kg)
F10T	aluminio	0,020

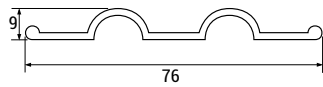

Perfil cartolilla de 76 mm., N°4

Referencia	Material	kg/m	Largo	Ancho
F4	Aluminio	0,450	5000	76

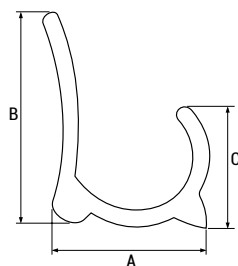

Perfil vierteaguas pequeño, N°8

Referencia	Material	kg/m	Largo	A	B	C
F8	aluminio	0,230	3000	21,5	32	17

BISAGRAS DE MALETERO BOOT HINGES

Bisagra maletero, N°1

Referencia	Material	Peso (kg)
FB1	aluminio	0,180

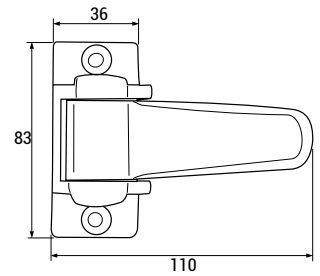
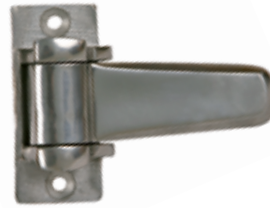

Bisagra maletero, N°2

Referencia	Material	Peso (kg)
FB2	aluminio	0,170

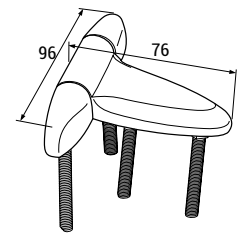

GUÍA Y GANCHOS DE CARNICERO MEAT HOOKS AND GUIDE RACK

Perfil guía para gancho de carnicero

Referencia	Material	kg/m	Largo
FGC	aluminio	1,980	3000

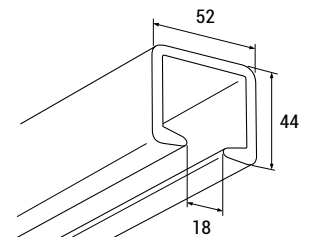
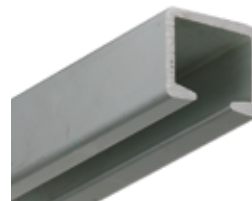

Soporte inoxidable para guía de carnicero

Referencia	Material	Peso (kg)
FSC	inoxidable	0,180

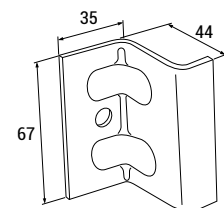

Juego de soportes para guía de carnicero con gancho y cadena

Referencia	Material	Peso (kg)
FJSC	inoxidable	0,420

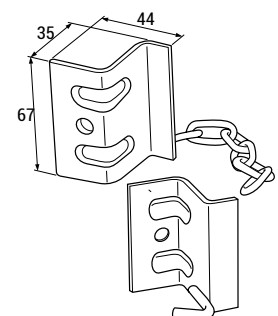



Gancho sencillo (con rueda de nylon) para carne

Referencia	Material	Peso (kg)	Largo
FGSN14	inoxidable	0,290	140
FGSN18	inoxidable	0,340	180

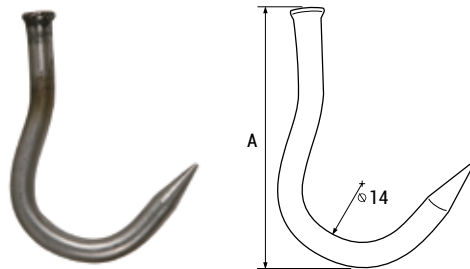

Gancho sencillo para carne

Referencia	Material	Peso (kg)	Largo
FG140	inoxidable	0,270	140
FG180	inoxidable	0,320	180

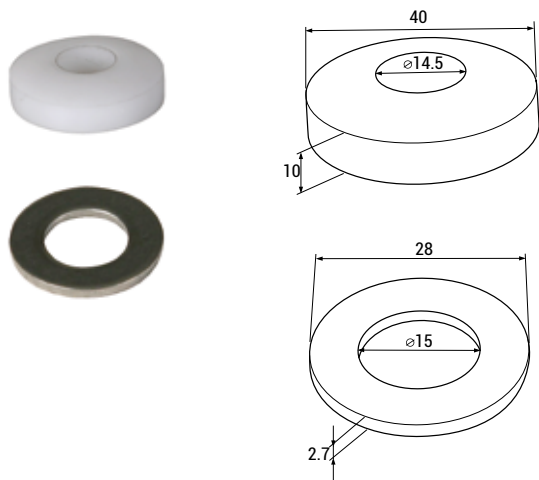

Juego rueda nylon/arandela (inox.) de gancho sencillo para carne

Referencia	Material	Peso (kg)
FJRC	nylon/inox	0,200



Auxiliar Carrocera S.A.
Pol. Landaben Calle A S/N
31012 Pamplona (Navarra)
Horario 8:30 – 13:30 / 15:30 – 18:30

Administración (+34) 948 18 73 16
Departamento comercial (+34) 948 18 85 19
669 044 143 - 696 001 017
www.auxiliarcarrocera.com
administracion@auxiliarcarrocera.com

**auxiliar
carrocera**

CATÁLOGO
CATALOGUE