



G

Páginas **116 - 129**



PERFILES DE GOMA
116 - 117



PERFILES DE GOMA FURGÓN
118



PERFILES DE GOMA PARA LATERALES Y PERFILES DE DOBLE DUREZA
119 - 121



TOPES DE GOMA
121 - 122



TOPES DE GOMA PARAGOLPES TRASERO
123



TOPES DE GOMA GIRATORIOS Y TOPES TRASERO DE PLATAFORMA
123 - 124



FALDILLAS Y FALDONES DE GOMA
125 - 126



SILENTBLOCK CHASIS, PEGAMENTO Y GOMA ESPONJOSA ADHESIVA
127 - 128

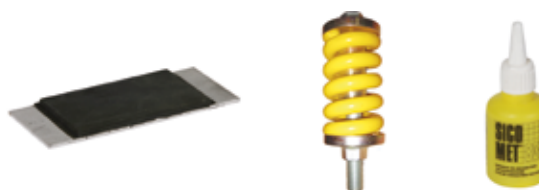

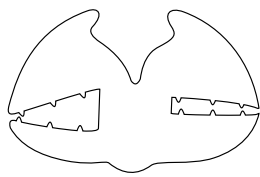

Goma parabrisas grande N°3

Referencia	Material	Acabado	Rollo mt
G3	goma	negro	25,00

Nota: se vende por metros

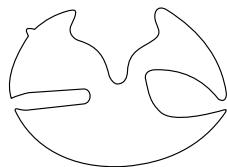

Goma parabrisas pequeña N°4

Referencia	Material	Acabado	Rollo mt
G4	goma	negro	25,00

Nota: se vende por metros

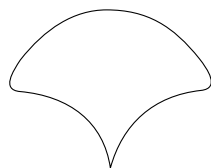

Junquillo parabrisas

Referencia	Material	Acabado	Rollo mt
GJ17N	goma	negro	100,00

Nota: se vende por metros

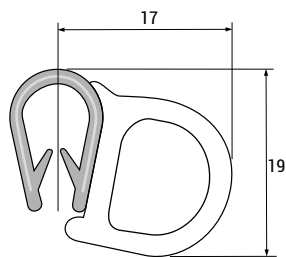

Goma puerta universal N°5

Referencia	Material	Acabado	Rollo mt	Cuerpo
G5	goma	negro	50,00	metálico

Nota: se vende por metros

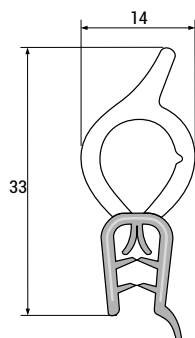

Goma puerta universal N°5 BIS

Referencia	Material	Acabado	Rollo mt	Cuerpo
G5P	goma	negro	25,00	metálico

Nota: se vende por metros

Junquillo plástico universal N°6

Referencia	Material	Acabado	Rollo mt	Cuerpo
G6	goma	negro	50,00	metálico

Nota: se vende por metros

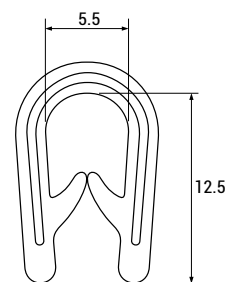

Goma de cartolas/laterales N°15

Referencia	Material	Acabado	Rollo mt
G15	goma	negro	40,00

Nota: se vende por metros

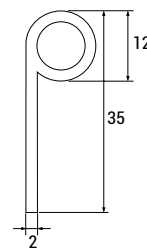

Goma N°7 (para perfil aluminio yugo de 45 mm. N°2)

Referencia	Material	Acabado	Rollo mt
G7	goma	negro	25,00

Nota: se vende por metros

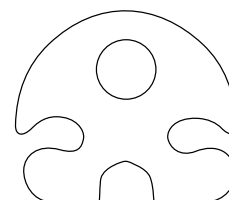

Perfil correspondiente



Ref. F2

Goma N°16 (para perfil aluminio yugo de 50 mm. N°10)

Referencia	Material	Acabado	Rollo mt
G16	goma	negro	50,00

Nota: se vende por metros

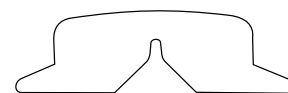

Perfil correspondiente



Ref. F10

Goma N°17

Referencia	Material	Acabado	Rollo mt
G17	goma	negro	25,00

Nota: se vende por metros

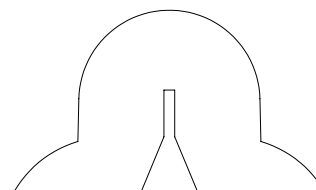
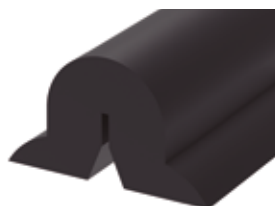

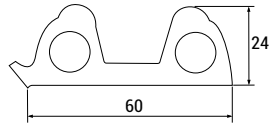
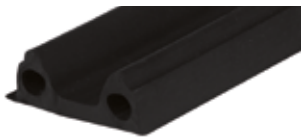

Goma rozadera N°19

Referencia	Material	Acabado	Rollo mt	Medidas (mm)
G19	goma	negro	25,00	60x24

Nota: se vende por metros

► PERFILES DE GOMA PARA PUERTAS

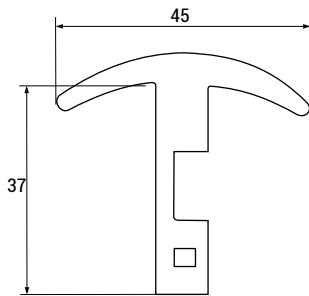

Perfil goma furgón N°13

Referencia	Material	Acabado	Largo
G13	goma	negro	4000

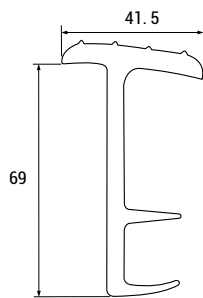

Perfil goma furgón grande N°20

Referencia	Material	Acabado	Kg/mt	Largo
G20	goma	blanco	1,06	4000

Nota: en unidades de cuatro metros

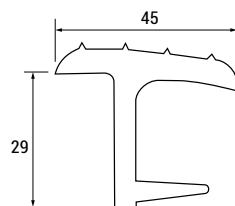

Perfil goma furgón pequeña N°21

Referencia	Material	Acabado	Kg/mt	Largo
G21	goma	blanco	0,64	4000

Nota: en unidades de cuatro metros

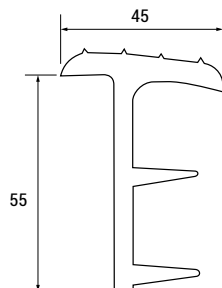

Perfil goma furgón mediana N°22

Referencia	Material	Acabado	Kg/mt	Largo
G22	goma	blanco	0,96	4000
G22N	goma	negro	0,96	4000

Nota: en unidades de cuatro metros

► GOMA PARA PERFILES DE ALUMINIO DE CARTOLA / LATERAL

Goma para perfil aluminio, N°1, N°9, N°19 y N°20

Referencia	Material	Acabado	Rollo mt
GP1	goma	negro y gris	50,00

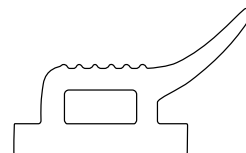
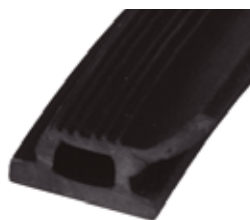

Perfiles correspondientes

Ref. HP1
Ref. HP9
Ref. HP1925
Ref. HP20

Goma c/ala para perfil alum., N°13, (N°1-N°1Bis. {Serie B}) y K20

Referencia	Material	Acabado	Rollo mt
GP13	goma	negro	100,00

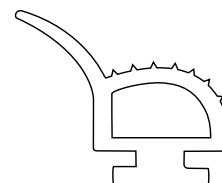

Perfiles correspondientes

Ref. HP1B
Ref. HP1BB
Ref. HP13

Goma sin ala para perfil de aluminio Kinnegrip K20

Referencia	Material	Acabado	Rollo mt
GP9K	goma	negro	125,00

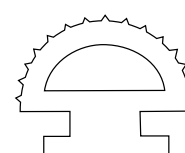

Perfil correspondiente

Ref. HP9K

Goma para perfil de aluminio, N°8, N°8 Bis. N°11 Bis. y N°14

Referencia	Material	Acabado	Rollo mt
GP11B	goma	negro	75,00

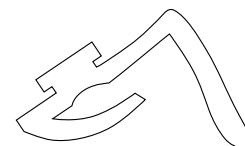
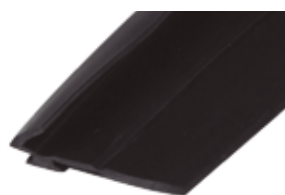

Perfiles correspondientes

Ref. HP8
Ref. HP8B/21
Ref. HP11B/B
Ref. HP14/B/L

Goma (gris) para ranura, del perfil aluminio, N°19 y N°20

Referencia	Material	Acabado	Rollo mt
GP20G	goma	gris	100,00

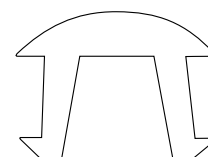
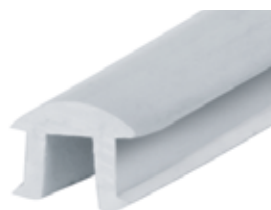

Perfiles correspondientes

Ref. HP1925
Ref. HP20

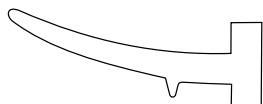

Goma para perfil de cierre aluminio en 25 mm.

Referencia	Material	Acabado	Rollo mt
GPCM25	goma	negro	125

Nota: se vende por metros

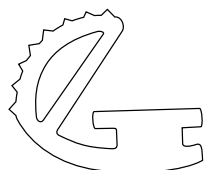

Goma para perfil de cierre aluminio en 30 mm.

Referencia	Material	Acabado	Rollo mt
GPCM30	goma	negro	125

Nota: se vende por metros

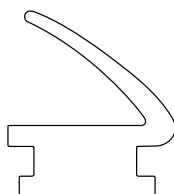

Goma "neutra" para perfil de cierre aluminio

Referencia	Material	Acabado	Rollo mt
GPCMN	goma	negro	125

Nota: se vende por metros

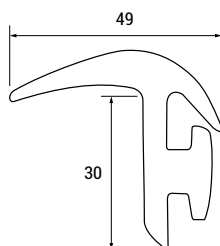

Goma N°23, para puerta trasera

Referencia	Material	Acabado	Largo
GPG	goma	gris	2800

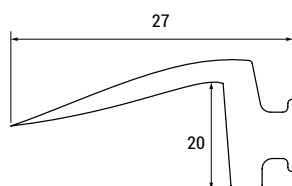
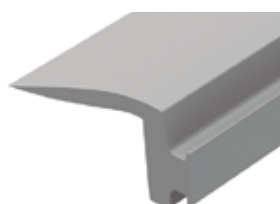

Goma solapa N°24 para perfil cierre aluminio

Referencia	Material	Acabado	Largo
GSCMA	goma	gris	2570

GOMA -DOBLE DUREZA- PARA PUERTA EXTRA HARD RUBBER

Perfil PVC -doble dureza- para puerta

Referencia	Material	Acabado	A	Largo
GDD21	pvc	gris/negro	21	4000
GDD25	pvc	gris/negro	25	4000
GDD30	pvc	gris/negro	30	5000
GDD40	pvc	gris/negro	40	4000
GDD55	pvc	gris/negro	55	5000
GDD65	pvc	gris/negro	65	5000
GDD85	pvc	gris/negro	85	5000

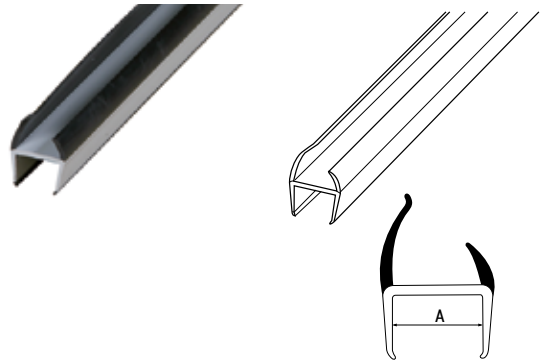

TOPES DE GOMA RUBBER BUFFERS

Tope goma de 2 cuerpos

Referencia	Material	Acabado	Peso (kg)
GT2	goma	negro/blanco	0,87

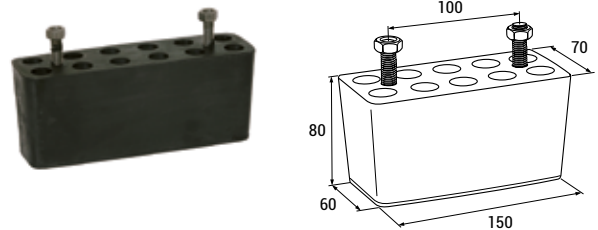

Tope goma de 3 cuerpos

Referencia	Material	Acabado	Peso (kg)
GT3	goma	negro/blanco	2,06

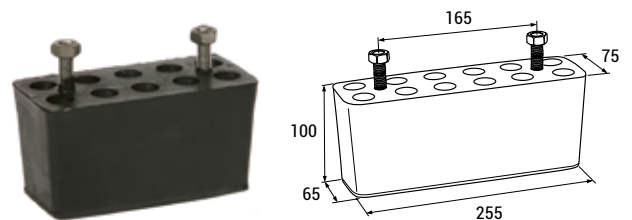

► TOPES DE GOMA (TIPO FRANCES)

Tope goma tipo frances de 115 mm.

Referencia	Material	Acabado	Peso (kg)
GTF115	goma	negro	0,88

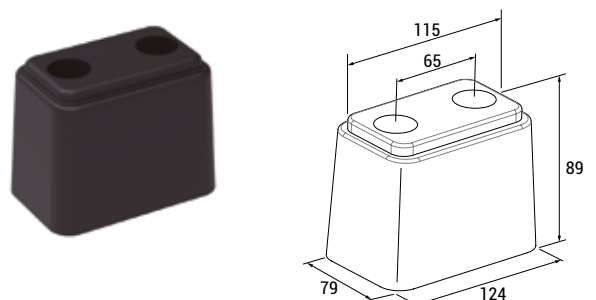

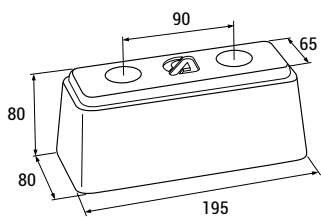

Topo goma tipo frances de 200 mm.

Referencia	Material	Acabado	Peso (kg)
GTF200	goma	negro	2,06

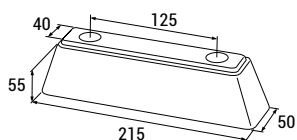

Topo goma tipo frances de 215 mm. "Mini"

Referencia	Material	Acabado	Peso (kg)
GTF215	goma	negro	0,56

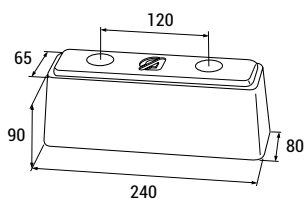

Topo goma tipo frances de 250 mm.

Referencia	Material	Acabado	Peso (kg)
GTF250	goma	negro	1,68

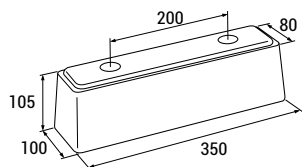

Topo goma tipo frances de 350 mm.

Referencia	Material	Acabado	Peso (kg)
GTF350	goma	negro	3,94

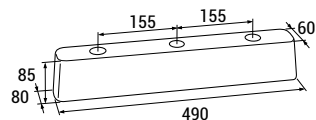

Topo goma tipo frances de 500 mm.

Referencia	Material	Acabado	Peso (kg)
GTF500	goma	negro	3,90

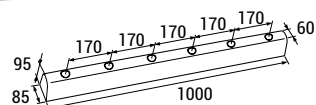

Topo goma tipo frances, de 1000 mm.

Referencia	Material	Acabado	Peso (kg)
GTF100	goma	negro	5,80

G

► TOPES DE GOMA (PARAGOLPES TRASERO)

Perfil goma tope furgón trasero de 80 x 65

Referencia	Material	Acabado	Kg/mt	Largo
GTTA	goma	negro	3,54	2500

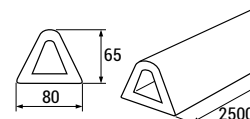

Perfil goma tope furgón trasero de 120 x 110

Referencia	Material	Acabado	Kg/mt	Largo
GTTB	goma	negro	7,86	2600

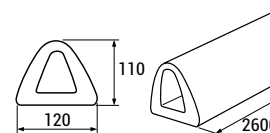

Perfil goma tope furgón trasero de 120 x 120

Referencia	Material	Acabado	Kg/mt	Largo
GTTC	goma	negro	11,05	2600

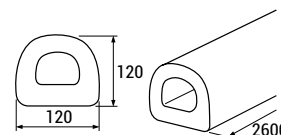

TOPES DE GOMA GIRATORIOS SWIVELING RUBBER BUFFERS WITH BRACKET

Tope giratorio horizontal de 1 rodillo goma (80 mm.) y soporte

Referencia	Material	Goma m/m	Peso (kg)
GTC1N	forja/goma	80	3,90

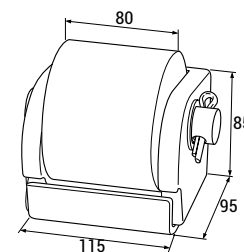

Tope giratorio horizontal de 1 rodillo goma (130 mm.) y soporte

Referencia	Material	Goma m/m	Peso (kg)
GTC1L	forja/goma	130	5,02

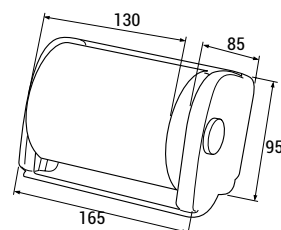

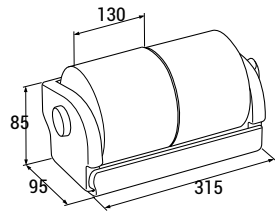

Tope giratorio horizontal de 2 rodillos goma (130 mm.) y soporte

Referencia	Material	Goma m/m	Peso (kg)
GTC2L	forja/goma	130	9,05

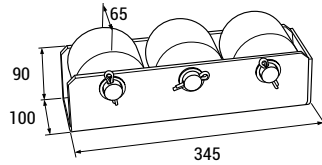

Tope giratorio vertical de 2 y 3 rodillos goma (65 mm.) y soporte

Referencia	Material	Goma m/m	Peso (kg)
GTC2VN	forja/goma	65	5,29
GTC3VN	forja/goma	65	7,76



Componentes para tope giratorio

Referencia	Descripción
GTCRN	rodillo goma cilindrico (80 mm.) {modelo "AC"}
GTCCR130	rodillo goma cilindrico (130 mm.) {modelo "AC"}
GTCCR65	rodillo goma cilindrico (65 mm.) {modelo "BR"}
GTCCR80	rodillo goma cilindrico (80 mm.) {modelo "BR"}
CTCR1L	rodillo goma cilindrico (130 mm.) {modelo "BR"}
GTCS1	soporte, de tope horizontal 1 rodillo goma (80 mm.)
GTCS1L	soporte, de tope horizontal 1 rodillo goma (130 mm.)
GTCS2L	soporte, de tope horizontal 2 rodillos goma (130 mm)
GTCS2C	soporte, de tope vertical de 2 rodillos goma (65 mm.)
GTCS3C	soporte, de tope vertical de 3 rodillos goma (65 mm.)
GTCE1	eje, para tope horizontal de 1 rodillo goma (80 mm.)
GTCE1L	eje, para tope horizontal de 1 rodillo goma (130 mm.)
GTCE2L	eje, para tope horizontal de 2 rodillos goma (130 mm)

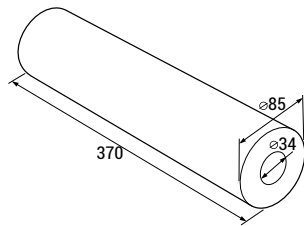

Tope goma giratorio (370 mm)

Referencia	Material	Acabado	Peso (kg)
GTG	goma	negro	2,12

TOPE TRASERO DE PLATAFORMA PLATFORM REAR BUMPER

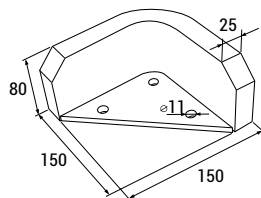

Tope angulo acero plataforma (modelo "B")

Referencia	Material	Acabado	Peso (kg)
GTTP	acero	cincado	4,6

FALDILLAS DE GOMA RUBBER MUDGUARDS

Faldillas de goma con antiproyección

Referencia	Material	Acabado	Peso (kg)	A	B
GFGA25	goma	negro	3,90	250	450
GFGA40	goma	negro	2,00	400	310
GFGA45	goma	negro	2,50	450	330
GFGA49	goma	negro	2,90	490	360
GFGA52	goma	negro	3,50	520	400
GFGA56	goma	negro	3,70	560	420
GFGA62	goma	negro	4,00	630	420

Nota: Para colocación por fuera de la aleta Se pueden servir grabadas



Suplemento interior de aleta goma con antiproyección

Referencia	Material	Acabado	Peso (kg)	A	B
GFGAS	goma	negro	3,00	640	640

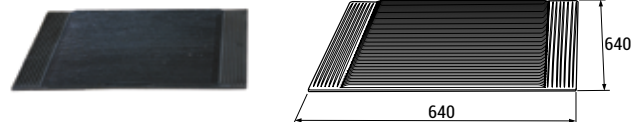

Faldones de goma con antiproyección

Referencia	Material	Acabado	Peso (kg)	A	B
GFA47	goma	negro	4,20	400	770
GFA457	goma	negro	5,20	450	770
GFA50	goma	negro	6,00	500	850
GFA50L	goma	negro	7,50	500	1000
GFA557	goma	negro	6,30	550	760
GFA55	goma	negro	7,00	550	830
GFA60	goma	negro	7,20	600	1000
GFA63	goma	negro	7,20	630	920
GFA64	goma	negro	6,50	640	760
GFA64L	goma	negro	6,90	640	850

Nota: Para colocación por dentro de la aleta Se pueden servir grabados



► FALDONES DE GOMA DE PARAGOLPES TRASERO

Faldón goma de paragolpes trasero (modelo "K")

Referencia	Material	Lado	Peso (kg)	Medida (mm)
GFTD	goma	derecho	3,50	1200 x 350
GFTI	goma	izquierdo	3,50	1200 x 350





Faldón goma en una pieza de paragolpes trasero (modelo "K")

Referencia	Material	Peso (kg)	Medida (mm)
GFTL	goma	7,00	2400 x 350

FALDONES LATERALES SIDE FLAPS

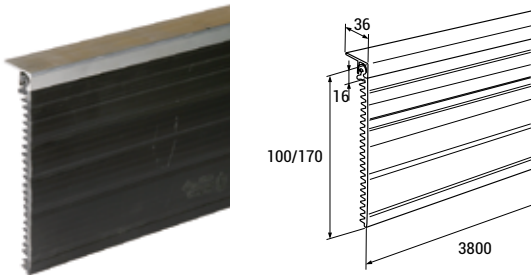

Faldón mixto aluminio-PVC lateral para banda (tipo "GB")

Referencia	Descripción	Peso (kg)	Medida (mm)
GALBI100	aluminio/pvc	3,64	100 x 3800
GALBI170	aluminio/pvc	6,19	170 x 3800

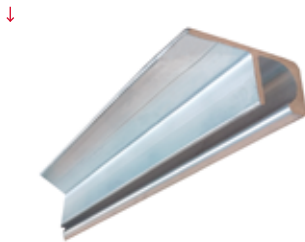

Complementos para faldón (tipo "GB")

Referencia	Descripción
GALBIP	Perfil aluminio lateral para banda (3800 mm.)-solo perfil
GALBIF100	Faldón pvc banda lateral (100 x 3800 mm.) -sin perfil-
GALBIF170	Faldón pvc banda lateral (170 x 3800 mm.) -sin perfil

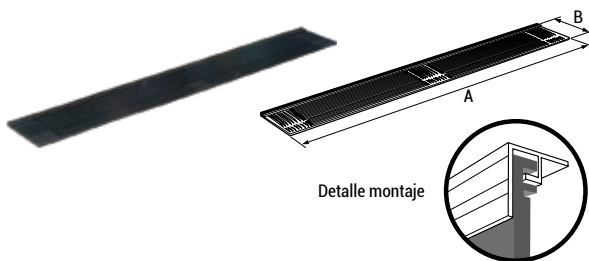

Faldón lateral goma con antiproyección (tipo "GFL")

Referencia	Material	Acabado	Peso (kg)	Peso (kg)
GFFA15	goma	negro	3,25	150 x 1335
GFFA20	goma	negro	3,50	200 x 1335

Nota: las referencias de este artículo son sin perfil

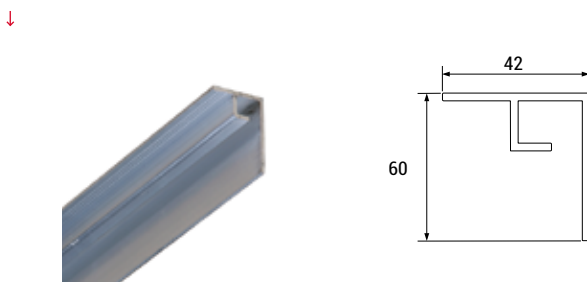

Perfil aluminio para faldon lateral (tipo "GFL")

Referencia	Material	Peso (kg)	Largo
GAFa	aluminio	1,02	4250

SILENTBLOCK CHASIS CHASSIS SILENTBLOCK

Silentblock chasis (acero / goma)

Referencia	Material	Alto (mm)	Peso (kg)	Chapa	Goma
GSV1	acero/goma	10	0,65	200 x 90	180
GSV2	acero/goma	20	1,29	400 x 60	360
GSV3	acero/goma	30	1,49	400 x 60	360
GSV4	acero/goma	40	1,68	400 x 60	360
GSV6	acero/goma	60	2,12	400 x 60	360

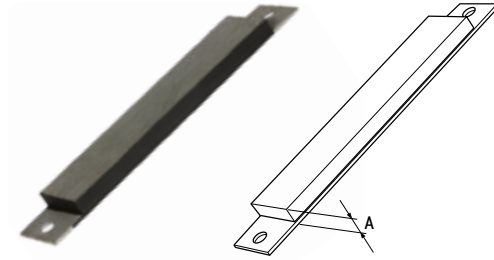

Silentblock chasis (aluminio / goma)

Referencia	Material	Alto (mm)	Peso (kg)	Chapa	Goma
GSVA	aluminio/goma	10	0,27	200 x 90	180

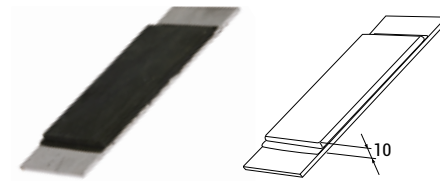

Silentblock chasis con muelle

Referencia	Material	Peso (kg)
GSCM	acero	1,02

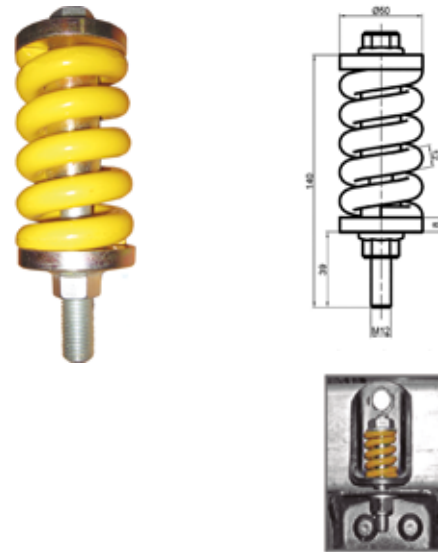

POSAPIES ESTRIBERA GOMA RUNNING BOARD RUBBER FOOTREST

Posapies estribera

Referencia	Material	Alto (mm)	Peso (kg)
GPL	goma	negro	0,19

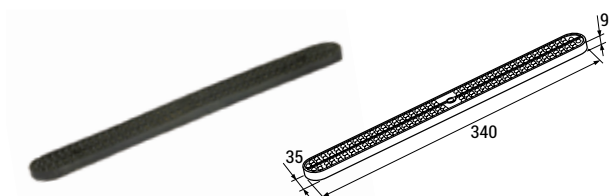

SUJETACAPOT RUBBER BONNET CATCH

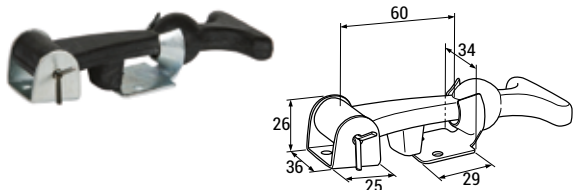

Sujetacapot goma (completo)

Referencia	Material	Acabado	Peso (kg)
GSC	goma	negro	0,88

GOMA ESPONJOSA ESPONGE RUBBER

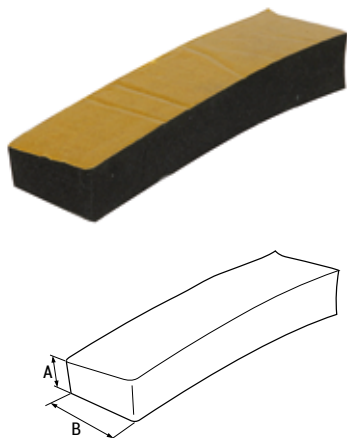

Goma esponjosa adhesiva

Ref.	Material	Tipo	AxB (mm)	Rollo mt
GA37	goma esponjosa	adhesiva	3 x 7	10
GA520	goma esponjosa	adhesiva	5 x20	12
GA525	goma esponjosa	adhesiva	5 x25	12, 20
GA530	goma esponjosa	adhesiva	5 x30	10
GA5120	goma esponjosa	adhesiva	5 x120	12
GA1015	goma esponjosa	adhesiva	10 x 15	12
GA1020	goma esponjosa	adhesiva	10 x 20	10, 12
GA1025	goma esponjosa	adhesiva	10 x 25	12
GA1030	goma esponjosa	adhesiva	10 x 30	10, 12
GA1040	goma esponjosa	adhesiva	10 x 40	12
GA1520	goma esponjosa	adhesiva	15 x 20	12
GA1525	goma esponjosa	adhesiva	15 x 25	12
GA1530	goma esponjosa	adhesiva	15 x 30	12
GA1540	goma esponjosa	adhesiva	15 x 40	10
GA2030	goma esponjosa	adhesiva	20 x 30	10
GA2040	goma esponjosa	adhesiva	20 x 40	12
GA3040	goma esponjosa	adhesiva	30 x 40	

PEGAMENTO GLUE



Bote de pegamento (sicomet)

Referencia	Material	Modelo	Peso (kg)
GPS	cianoacrilato	8300	0,05

Nota: Une metales, plásticos y elastómeros en segundos

Auxiliar Carrocera S.A.
Pol. Landaben Calle A S/N
31012 Pamplona (Navarra)
Horario 8:30 – 13:30 / 15:30 – 18:30

Administración (+34) 948 18 73 16
Departamento comercial (+34) 948 18 85 19
669 044 143 - 696 001 017
www.auxiliarcarrocera.com
administracion@auxiliarcarrocera.com

**auxiliar
carrocera**

CATÁLOGO
CATALOGUE