



Páginas **156 - 161**

ESCALERAS BAJO CHASIS
156 - 157



ESTRIBOS Y REJILLAS
158 - 159



CLARABOYA, VENTANAS Y AMORTIGUADORES
159 - 160



TAPACUBOS DE RUEDA
160 - 161



Pamplona



► ESCALERAS BAJO-CHASIS



Escalera bajo-chasis de 1 peldaño (350 mm.) modelo "E"

Referencia	Material	Acabado	Peldaños	Peso (kg)
IE1E	acero	cincado	1	3,70



Escalera bajo-chasis de 2 peldaños (650 mm.) modelo "E"

Referencia	Material	Acabado	Peldaños	Peso (kg)
IE2E	acero	cincado	2	4,46

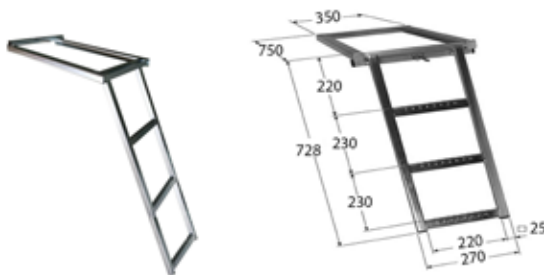

Escalera bajo-chasis de 3 peldaños (750 mm.) modelo "E"

Referencia	Material	Acabado	Peldaños	Peso (kg)
IE3E	acero	cincado	3	6,70

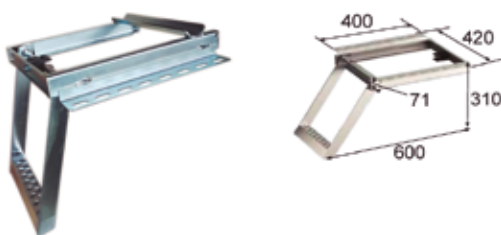

Escalera bajo-chasis (c/ángulos sujeción), 400 mm.(1 peldaño)

Referencia	Material	Acabado	Peldaños	Peso (kg)
IE1DS	acero	cincado	1	4,30



Escalera bajo-chasis (c/ángulos sujeción), 660 mm.(2 peldaños)

Referencia	Material	Acabado	Peldaños	Peso (kg)
IE2DS	acero	cincado	2	6,00
IE2DI	inoxidable		2	5,88

Escalera bajo-chasis (c/ángulos sujeción), 750 mm.(3 peldaños)

Referencia	Material	Acabado	Peldaños	Peso (kg)
IE3DS	acero	cincado	3	7,45
IE3DI	inoxidable		3	7,30

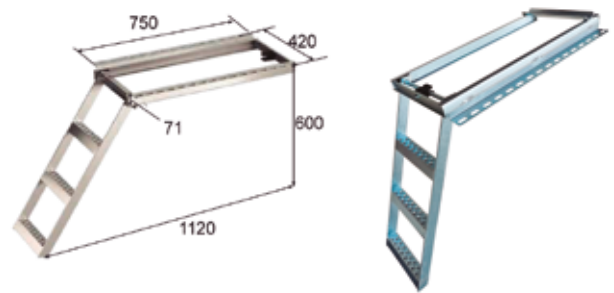

► ESCALERAS BAJO-CHASIS (PARA FRIGORIFICOS)

Escalera bajo-chasis (4 peldaños) de 1790 x 640 mm.

Referencia	Material	Acabado	Peldaños	Peso (kg)
IE4E	acero	cincado	4	40,00

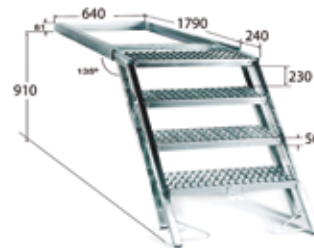

Escalera bajo-chasis (5 peldaños) de 2070 x 635 mm.

Referencia	Material	Acabado	Peldaños	Peso (kg)
IE5E	acero	cincado	5	47,50

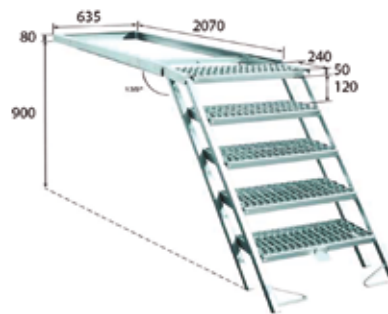

Escalera bajo-chasis (6 peldaños) de 2065 x 710 mm.

Referencia	Material	Acabado	Peldaños	Peso (kg)
IE6E	acero	cincado	6	49,40

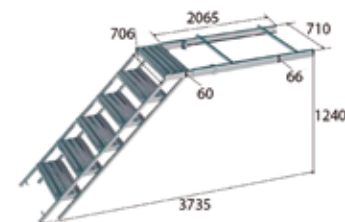

► ESCALERA ABATIBLE

Escalera abatible de 2 peldaños (modelo "TK")

Referencia	Material	Acabado	Peldaños	Peso (kg)
IE2T	acero	cincado	2	14,40

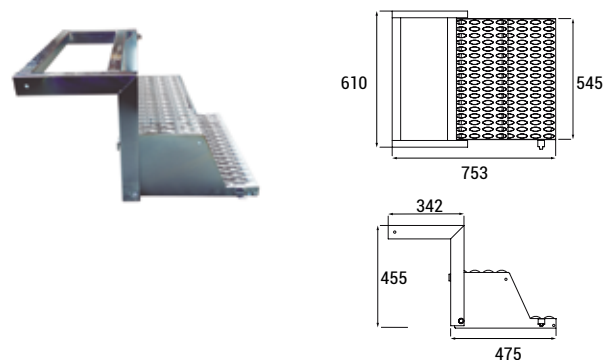

► ESCALERA TELESCÓPICA



Escalera telescópica

Referencia	Material	Peldaños	Peso (kg)	Medida (mm)
IET9	aluminio	8	6,06	2600 x 470

Nota: Medida recogida 670 x 470 mm.

ESTRIBOS FOOTREST

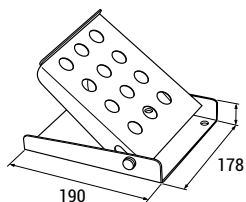

Estribo abatible

Referencia	Material	Acabado	Peso (kg)
IEA	acero	cincado	1,14

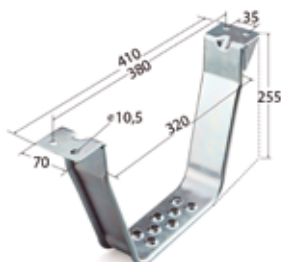

Peldaño fijo cincado (Modelo 2728).

Referencia	Material	Acabado	Peso (kg)
IPFC2728	acero	cincado	1,12

REJILLAS VENTILACIÓN VENTILATION SYSTEMS

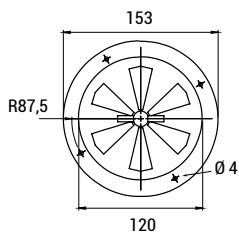

Rejilla redonda de aireador con protector

Referencia	Material	Peso (kg)
IAIP	inoxidable	0,18

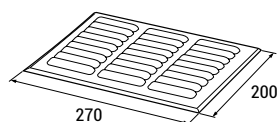
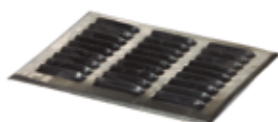

Rejilla rectangular

Referencia	Material	Peso (kg)
IRV	aluminio	0,14

AIREADOR DE TECHO ROOF AIRING DEVICE

Aireador giratorio de techo por inercia

Referencia	Material	Acabado	Peso (kg)
IAG	plástico	negro	0,87

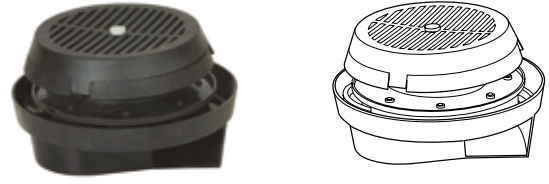

CLARABOYA DE TECHO ROOF SKYLIGHT

Claraboya techo, de 400 x 400 mm. (con mosquitera)

Referencia	Material	Peso (kg)
ICT	plástico	2,38

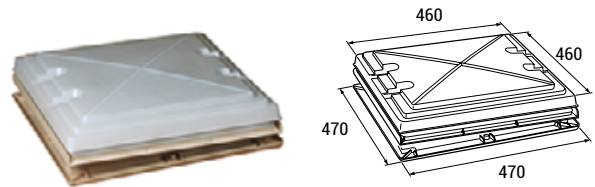

VENTANAS LATERALES SIDE WINDOW

Ventana lateral corredera (sencilla), de 590 x 510 mm.

Referencia	Peso (kg)	Medidas (mm)
IVLSA	7,34	590 x 510

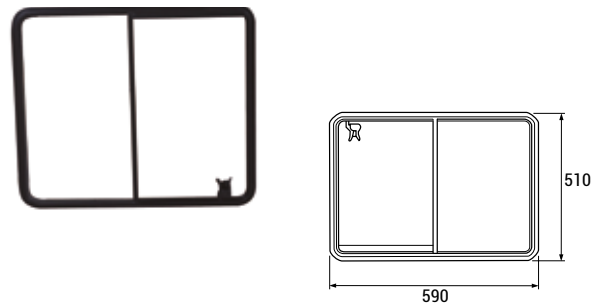

Ventana lateral corredera (doble), de 1200 x 510 mm.

Referencia	Peso (kg)	Medidas (mm)
IVLD	7,34	1200 x 510

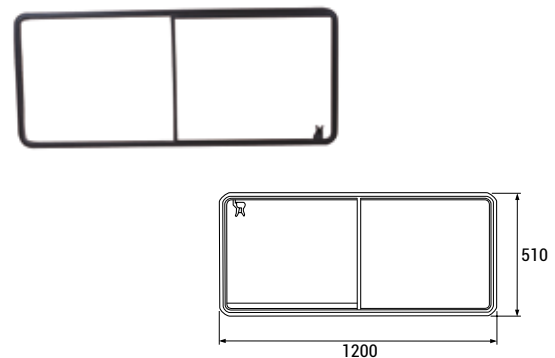

AMORTIGUADORES SHOCK ABSORBERS

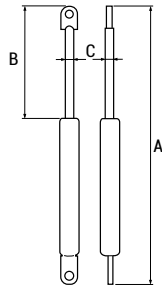

Amortiguador para carro final de plegador Auxilón

Referencia	Material	Potencia (N)	Largo	Carrera	∅	Peso (kg)
IAC50	acero	50	335	125	8	0,19
IAC60	acero	60	335	125	8	0,19
IAC80	acero	80	335	125	8	0,20
IAC100	acero	100	335	125	10	0,22

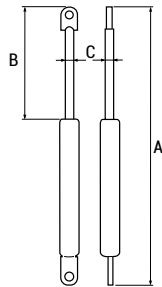

Amortiguador universal

Referencia	Material	Potencia (N)	Largo	Carrera	∅	Peso (kg)
IA25	acero	25	250	90	8	0,13
IA28	acero	28	255	90	8	0,14
IA35C	acero	35	350	125	8	0,18
IA35L	acero	35	540	240	8	0,27
IA45	acero	45	540	240	8	0,27
IA60	acero	60	540	240	8	0,27
IA70	acero	70	540	240	8	0,34
IA80	acero	80	1000	410	8	0,79
IA2590	acero	90	250	80	8	0,18

TAPACUBOS DE RUEDA WHEEL HUBCAPS

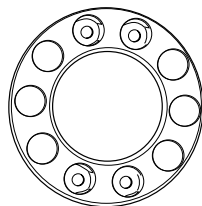

Tapacubos 10 agujeros, N°3

Referencia	Material	Acabado	Peso (kg)
I3	inoxidable	abierto	1,02

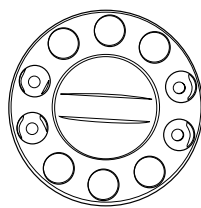

Tapacubos 10 agujeros, N°3 (con o sin anagrama)

Referencia	Material	Acabado	Peso (kg)
I3I	inoxidable	cerrado	1,32

Tapacubos "Vinci" (delantero)

Referencia	Material	Posición	∅	Peso (kg)
ITV17D	inoxidable	delantero	17,5"	1,06
ITV19D	inoxidable	delantero	19,5"	1,2
ITV22D	inoxidable	delantero	22,5"	1,41

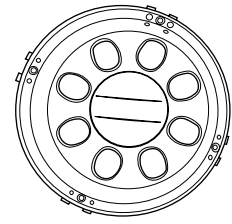

Tapacubos "Vinci" (trasero)

Referencia	Material	Posición	∅	Peso (kg)
ITV17T	inoxidable	trasero	17,5"	0,96
ITV19T	inoxidable	trasero	19,5"	1,16
ITV22T	inoxidable	trasero	22,5"	1,52

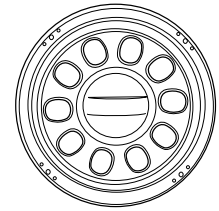

Auxiliar Carrocera S.A.
Pol. Landaben Calle A S/N
31012 Pamplona (Navarra)
Horario 8:30 – 13:30 / 15:30 – 18:30

Administración (+34) 948 18 73 16
Departamento comercial (+34) 948 18 85 19
669 044 143 - 696 001 017
www.auxiliarcarrocera.com
administracion@auxiliarcarrocera.com

**auxiliar
carrocera**

CATÁLOGO
CATALOGUE